



NEWSLETTER #1



6green.eu



Green Technologies for 5/6G Service-Based Architecture

ISSUE HIGHLIGHTS



The first issue of the 6Green Newsletter presents the project activities during the first reporting period, January 2023-June 2024.

This specific issue focuses on the project overview, communication and dissemination activities, the project deliverables, and the project meetings. It also provides an overview of the project, its use cases and Consortium members.



Project Overview

The 6Green project aims to conceive, design, and realize an innovative service-based and holistic ecosystem, able to extend “the communication infrastructure into a sustainable, interconnected, greener end-to-end intercompute system” and promote energy efficiency across the whole 5/6G value chain.

The ultimate objective is to enable and foster 5/6G networks and vertical applications that reduce their carbon footprint by a factor of 10 or more.

To achieve this objective, the project will exploit and extend state-of-the-art cloud-native technologies and the B5G Service-Based Architecture with new cross-domain enablers to:

- Boost the global ecosystem flexibility, scalability and sustainability, and
- Enable all the 5/6G stakeholders (from those acting at the infrastructure and network platform to vertical industries) to reduce their carbon footprint by becoming integral parts of a win-win green economy business and meeting a Decarbonization Level Agreement.

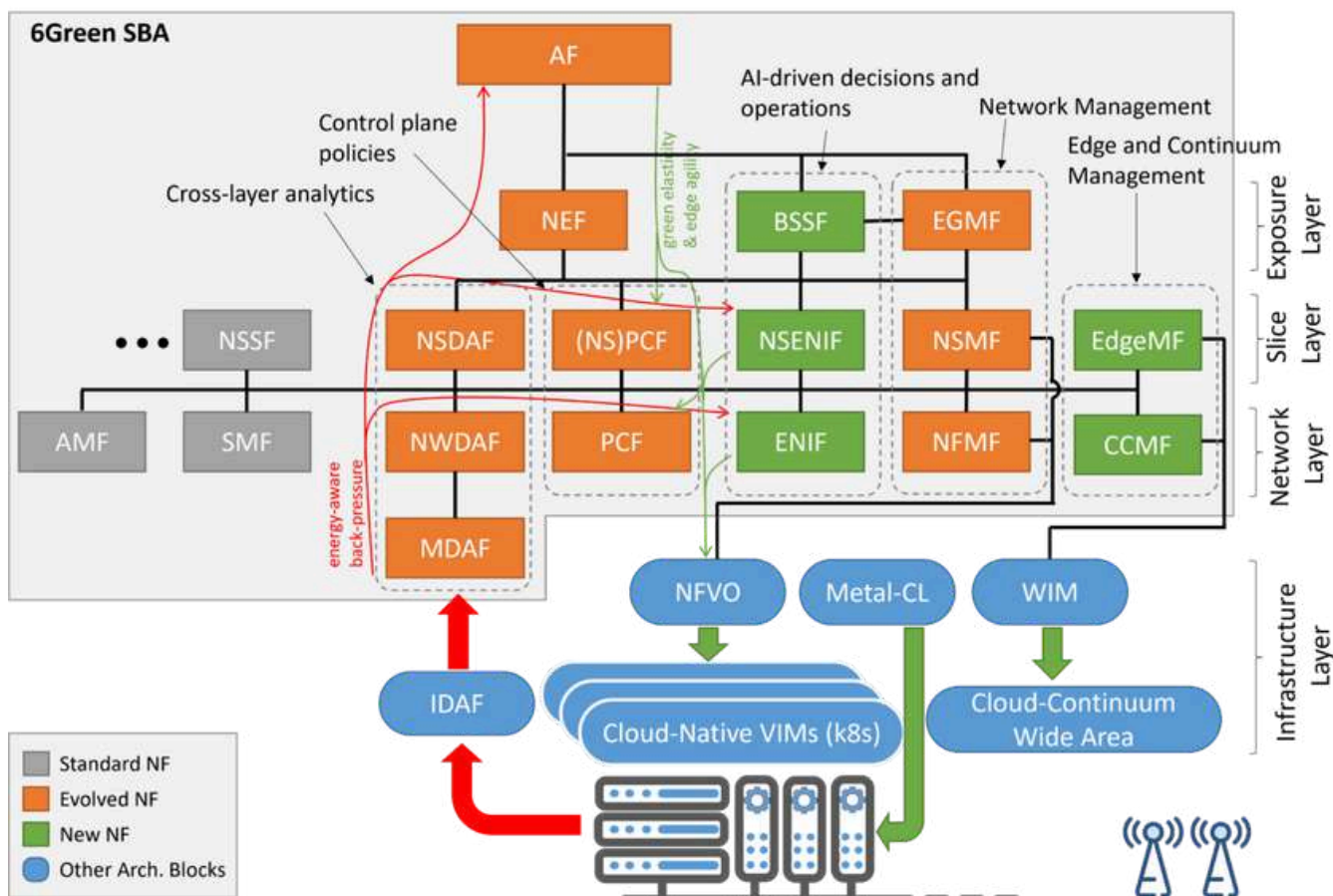

Vision & Objectives

- To promote the transition from classical “Cloud Agility” schemes to a novel “Edge Agility” paradigm.
- To introduce the “Green Elasticity” paradigm
- To enable the “Carbon/Energy-aware Backpressure” in the 5/6G SBA.
- To integrate the B5/6G SBA with new green AI mechanisms.
- To enable new green 5/6G business models and Decarbonized Service Agreements among stakeholders.
- To demonstrate and validate the project achievements in three use cases.

VISION

The 6Green project aims to create an innovative, service-based and holistic ecosystem to extend 5/6G networks and vertical applications, reducing their carbon footprint by a factor of 10 or more.

The project will exploit and extend state-of-the-art cloud-native technologies and the Beyond 5G (B5G) Service-Based Architecture (SBA) with new cross-domain enablers to boost the global ecosystem flexibility, scalability and sustainability.

Green Technologies For 5/6G Service-Based Architectures

6Green Use Cases

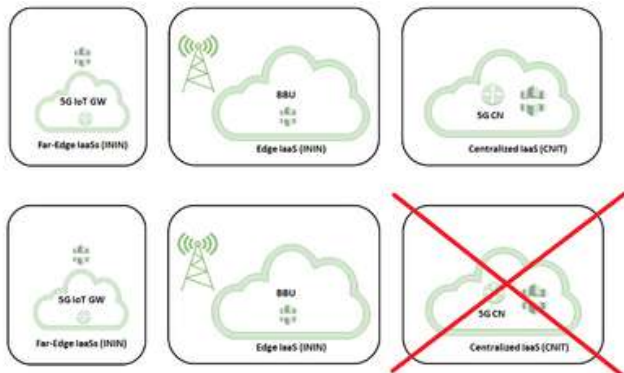

Use-Case #1: Critical Operation Maintenance during Energy-Constraint Disaster Scenarios

Evaluation of the consequences of a disaster for the infrastructure essential for the functioning of a society and economy), and identification of countermeasures to preserve stability and reduce negative impact for society and economy.

Use-Case #2: Energy-Efficient Augmented Reality Remote Assistance System

Evolution of a Remote Visual Assistance from a remote optimization tool for manufacturers towards a key solution for verticals to get closer to carbon neutrality, with AR features to collect live data and share it remotely to improve energy efficiency.

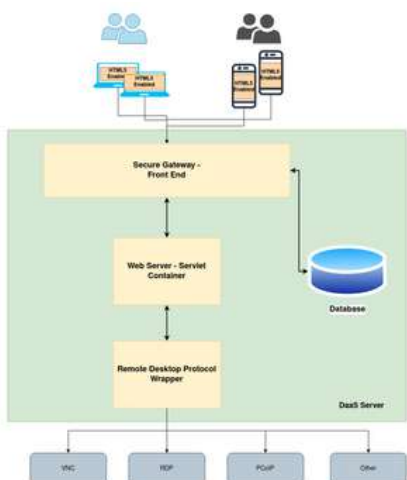
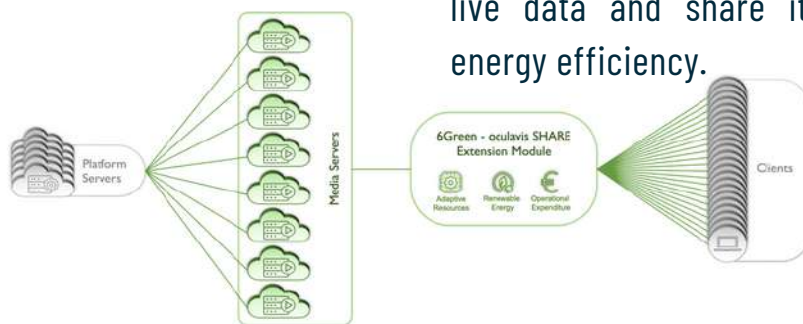

Use-Case #3: Zero-Carbon Clientless Virtual Enterprise Desktop as-a-Service

Shift most DaaS tasks from clients to servers to provide native 5/6G benefits such as security, slice integration with the private enterprise network infrastructure, and reduce GHG emissions.

EDGE AGILITY

The Edge Agility paradigm is meant to provide smart, fast, and automated horizontal scalability to vertical applications and related slices across the 5/6G edge-cloud continuum.

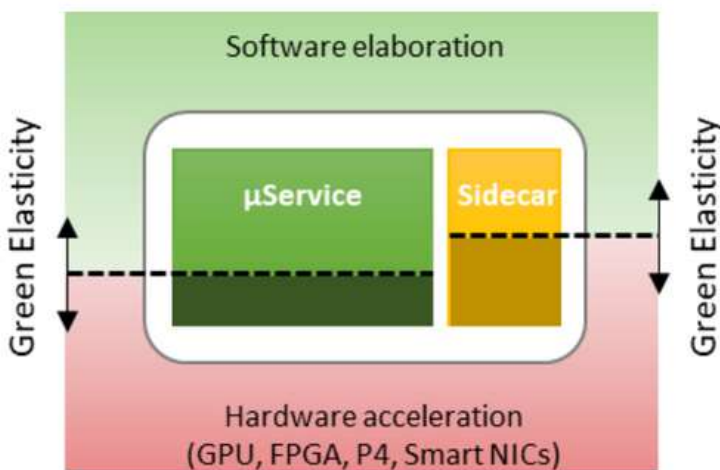
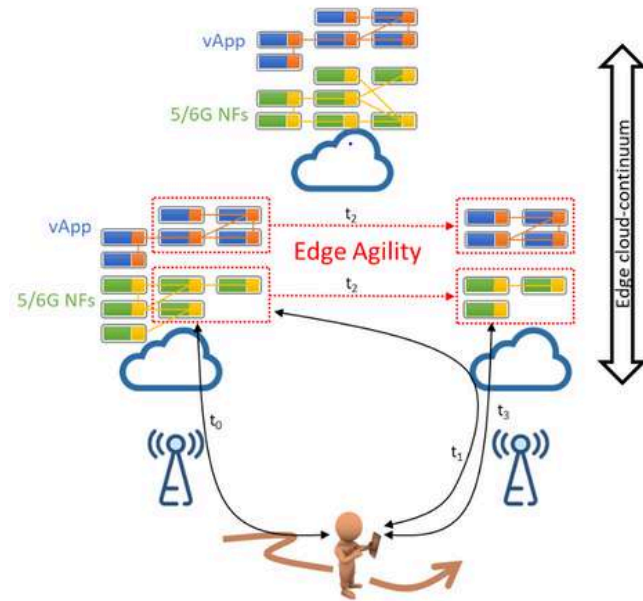

GREEN ELASTICITY

The provision of energy-aware, hardware-assisted acceleration to network functions and vertical applications to enable smart vertical scalability across the whole 5/6G ecosystem.

ENERGY-AWARE BACKPRESSURE

The design of a set of cross-domain observability mechanisms and analytics, fed by hardware-level energy consumption metrics, to evaluate the energy and the carbon footprint ascribable to a vertical application or a slice.

Communication & Dissemination activities



SELECTED EVENTS

GreenNet 2024 : 9 & 13 June 2024, Denver, Colorado, USA.

6Green co-organized the 3rd International Workshop on Green and Sustainable Networking (GreenNet), which was co-located with the IEEE International Conference on Communications (IEEE ICC) 2024 in Denver, Colorado, USA.

GreenNET explored novel networking issues that promote energy efficiency and sustainability of the complete network using monitoring and management solutions from data generation to data processing and further usage.

Raffaele Bruno presented the 6Green perspective on the interactive panel "How to achieve energy efficient and sustainable networking in the 6G age!"



EuCNC & 6G Summit : 3-6 June 2024, Antwerp, Belgium

The 6Green project participated in this year's EuCNC & 6G Summit in Antwerp. The project co-organized Workshop 7: "Sixtainability: Paving the Way for a Sustainable 6G" to explore more about Sustainability, Green Energy and 6G Networks!!

Sixtainability: Paving the Way for a Sustainable 6G

Monday, 3 June 2024, 9:00-12:30, Room Galapagos

Organisers:

- Mir Ghoraihsis (Gigasys Solutions, UK)
- Chiara Lombardo (Univ. of Genoa, IT)
- Artur Hecker (Huawei Munich Research Centre, DE)

Motivation and Background

Recent events like the advent of modern mobile networking in the 90s or the smartphone revolution of 2006 have clearly demonstrated the potential to transform the economic and societal prospects of people and industries. Experts have divided sustainability into three primary pillars: social sustainability, economic sustainability, and environmental sustainability. Future mobile network (6G) is a crucial means to achieve sustainability goals in each of these pillars. In fact, in the ongoing vision-building and research toward next generation mobile networks, not only sustainability of the 6G systems is considered as one of the most crucial topics, but also the ways 6G can enable sustainability in other sectors of the industry and society is attracting attentions. Sustainability is attracting more attention in recent years due to the rare alignment of several factors:

Communication & Dissemination activities

IEEE WCNC 2024 : 21-24 April 2024, Dubai, United Arab Emirates

PN-02: ENERGY EFFICIENCY IN WIRELESS COMMUNICATIONS NETWORKS, 5G TO 6G CHALLENGES AND OPPORTUNITIES

(Tuesday, 23 April, 14:00 GMT+4)

Room: Ballroom B, 4th Floor

The panel will discuss following topics:

- Energy efficiency in wireless network, discuss the challenges and opportunities.
- Major energy consumers in wireless network and their evolution from 5G to 6G
- Metrics of energy efficiency in current and future mobile networks
- Challenges of using AI for improving network energy efficiency: AI sustainability, AI energy consumption
- Evolution of the service-based architecture (SBA), from 5G to 6G, to improve energy efficiency
- What could be the role of Open RAN paradigm in sustainability and energy efficiency enhancement of the network?

PROGRAM

00:00 – 00:10 Introduction on the Topic and Panelists – Dr Mir Ghoraiishi (CEO, Project Manager, Gigasys Solutions)

00:10 – 00:20 Sustainability as a Key Criterion for Network Design on the Path to 6G; Dr Volker Ziegler (Senior Advisor, Chief Architect, Nokia)

00:20 – 00:30 Sustainability in 6G, Challenges and Opportunities; Prof. Merouane Debbah (Professor at Khalifa University, Director of the KU 6G Research Centre)

00:30 – 00:40 – Sustainable AI for mobile networks: challenges and GREENEDGE and VERGE projects solutions; Dr Paolo Dini (Senior Researcher and Coordinator of Sustainable Artificial Intelligence Research Unit, CTTC/CERCA)

00:40 – 00:50 A Win-Win Approach towards 6G Sustainability: 6Green green economical approach for infrastructure and virtual stakeholders to join forces towards a common efficiency goal; Dr Chiara Lombardo (Researcher at University of Genoa)

00:50 – 00:60 What ORAN Can Offer to Facilitate Enhancing Energy Efficiency in 6G: BeGREEN ORAN based intelligent solutions for enhanced energy efficiency in radio access; Dr Mir Ghoraiishi (CEO and Project Manager, Gigasys Solutions)

00:60 – 00:90 Panel discussion (with involvement of audience)

Carbon Aware Networks Workshop 202: 19-20 September 2023, Oxford, United Kingdom

On September 20th, 6Green partner Telefonica participated in the Carbon Aware Networks Workshop 2023 organized by Oxford University. The very interesting presentation was entitled "Sustainability on Carrier Transport Networks"

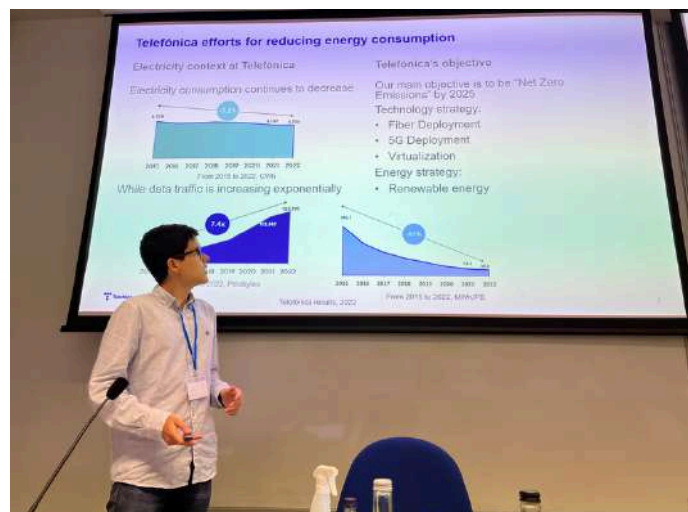

Communication & Dissemination activities

2023 IEEE Global Communications Conference (GLOBECOM):4-8 December 2023. Kuala Lumpur, Malaysia.



Chiara Lombardo presented a 6Green-supported paper entitled "A Packet Delay Emulator for High-Bandwidth and Low-Latency Traffic in 5G Networks", at IEEE GLOBECOM 2023.

GLOBECOM is one of the IEEE Communications Society's two flagship conferences dedicated to driving innovation in nearly every aspect of communications. GLOBECOM 2023 was themed "Intelligent Communications for Shared Prosperity", featuring a comprehensive, high-quality technical program including 13 symposia and a variety of tutorials and workshops.

ETSI Research Conference:6-8 February 2023. Sophia Antipolis, France

6Green participated in the ETSI Research Conference: Maximizing the Impact of European 6G Research through Standardization. Partner CNIT presented a poster highlighting the project's vision and objectives.

Communication & Dissemination activities

REFRESH 2023 workshop: 19 June 2023, Paphos, Cyprus

6Green partner ICCS successfully organized the REFRESH 2023 workshop. In this context, issues, challenges, and solutions for sustainability in 6G and how 6Green aims to tackle these were presented at the "4th International Workshop on Real-life modeling in 5G/6G networks and beyond."



EXHIBITIONS

MWC 2023: 27 February - 2 March 2023, Barcelona, Spain

6Green was present at MWC 2023 in Barcelona, the world's largest and most influential connectivity event. More than 88,500 attendees attended, of whom 56% came from sectors adjacent to the mobile ecosystem.

Partner ATHONET advertised the 6Green concept through the projection of project material on the screen of Athonet's booth at the "Mobile World Congress 2023" in Barcelona.

EENA Conference & Exhibition 2023: 19-21 April 2023, Ljubljana, Slovenia

Partner ININ showcased 6Green's scope, technologies, innovations, and goals at the "EENA Conference & Exhibition 2023."

IEEE ICC 2023: 28 May - 1 June 2023, Rome, Italy

Partner CNIT presented 6Green innovations on a mobile testbed at the "2023 IEEE International Conference on Communications". IEEE ICC 2023 focused on "Sustainable Communications for Renaissance", featuring a comprehensive high-quality technical program including 13 symposia and a variety of tutorials and workshops.

Communication & Dissemination activities

»»» PRESS RELEASE

On March 14, 2023, partner Orange presented its involvement in Horizon Europe 6G research projects with a press release in the Romanian business information and promotion platform "Doingbusiness.ro" including a description of 6Green.

ORANGE ROMANIA SE IMPLICA IN 6 PROIECTE DE INOVATIE HORIZON EUROPE CE VOR CONTRIBUI LA DEZVOLTAREA SUSTENABILA A 5G SI VOR DESCHIDE DRUMUL SPRE 6G

ORANGE ROMANIA SA 14 Mar 2023

Horizon Europe este un ambitios program de cercetare si inovare finantat de Uniunea Europeana, derulat in perioada 2021-2027

Orange Romania face pasi importanti pentru standardizarea la nivel global a tehnologiei 5G, dezvoltarea sustenabila a retelelor mobile, asigurarea securitatii cibernetice si definirea viitoarelor generatii de retele 6G, prin implicarea in 6 proiecte de cercetare in cadrul Horizon Europe. Horizon Europe este un ambitios program de cercetare si inovare finantat de Uniunea Europeana, derulat in perioada 2021-2027. Acesta adreseaza schimbarile climatice si isi propune sa contribuie la atingerea obiectivelor de dezvoltare durabila ale ONU, dar si sa stimuleze cresterea economica si competitivitatea la nivelul UE.

Participarea Orange in proiectele Horizon Europe si dezvoltarea noilor tehnologii de comunicatii nu ar fi fost posibile fara resursele oferite de Orange 5G Lab, un hub in care mediul academic, startup-urile si companiile pot sa inoveze si sa testeze solutiile bazate pe tehnologia 5G. 5G Lab face parte dintr-o initiativa internationala a Orange care isi propune sa sprijine actorii economici si cercetatorii in descoperirea utilitatii si a oportunitatilor aduse de 5G in dezvoltarea solutiilor care vor face diferenta intr-o economie digitala. Astfel, cu ajutorul resurselor din [Orange 5G Lab](#), dar si a specialistilor din mediul academic si cel privat, in Romania vor fi realizate in urmatoorii 5 ani mai multe studii de caz si experimente pentru cele 6 proiecte:

- **6Green** - obiectivul proiectului este sa dezvolte un ecosistem inovator ce inglobeaza infrastructura de comunicatii 5G/6G si aplicatiile sustinute de acestea intr-un mod sustenabil, ce va permite reducerea amprentei de CO2 de pana la 10 ori fata de tehnologiile folosite in prezent. Eficienta energetica va fi atinsa prin utilizarea noilor tehnologii radio care optimizeaza puterea de transmisie si directia undei radio in functie de pozitia utilizatorilor. Totodata, foloseste solutii software capabile sa scaleze in mod autonom resursele de calcul si radio in functie de gradul de incarcare a retelei.

»»» MEDIA ARTICLE

Parter CNIT published a newspaper article on 6G and sustainability. The article "La strada verso il 6G passa attraverso AI e sostenibilità" was published in the Italian business newspaper "Il Sole 24 Ore", discussing the issue of sustainability for 6G and how 6Green wishes to tackle these.

Plenary Meetings

6Green Kick off Meeting

On January 12th and 13th, 2023, representatives of the 6Green Partners held the project's Kick-off Meeting virtually.

The participants introduced their teams and their roles in the project, and CNIT, as the Project Coordinator, opened the meeting. The meeting continued with the project's technical aspects and partners' presentations.



6Green Kick Off Meeting

6Green Kick Off Meeting

The 6Green kick off meeting has been held remotely on 12-13 January 2023.

Genoa & Athens Plenary Meetings

The 2nd 6Green plenary meeting took place in **Genoa** on the 8th and 9th of March 2023.

The third plenary meeting, hosted by ICCS, was successfully held in **Athens** on October 25th and 26th. During these meetings, the project partners engaged in fruitful discussions and shared valuable insights about the project's progress and their future plans and actions.



Plenary Meetings

Fornebu Plenary Meeting

The 4th Plenary meeting of the 6Green project took place on April 16 and 17, 2024. Telenor organized and hosted the event on its premises in Fornebu, Norway.

The WP leaders, alongside the task leaders, presented the work and progress made across the project. Focus was put on the various technical aspects of the project.



6Green at the SNS Lunchtime Webinar

Dr. Chiara Lombardo from partner CNIT presented the 6Green project, along with the other SNS Phase-1 projects, during a webinar on 20 February 2023.

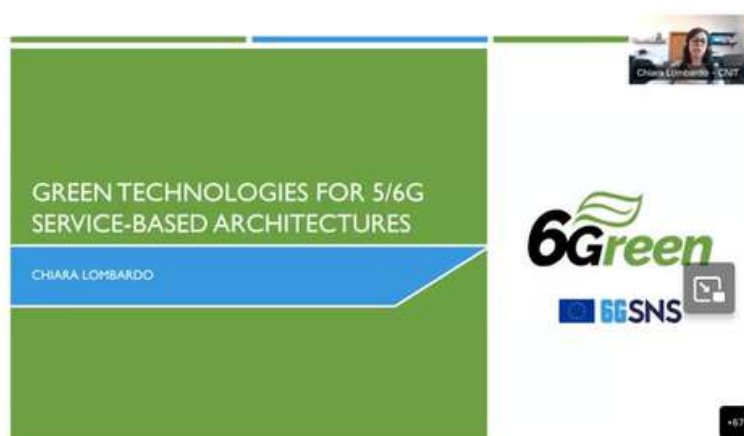

6Green Printed Material

6Green Poster and Brochure are now Available



Vision

The 6Green project aims to create an innovative, service-based and holistic ecosystem to extend 5/6G networks and vertical applications, reducing their carbon footprint by a factor of 10 or more. The project will exploit and extend state-of-the-art cloud-native technologies and the Beyond 5G (B5G) Service-Based Architecture (SBA) with new cross-domain enablers to boost the global ecosystem flexibility, scalability and sustainability.

Use Cases

- UC1: Critical Operation Maintenance during Energy-Constraint Disaster Scenarios
- UC2: Energy-Efficient Augmented Reality Remote Assistance System
- UC3: Zero-Carbon Clientless Virtual Enterprise Desktop as-a-Service

Objectives

- To promote the transition from classical "Cloud Agility" schemes to a novel "Edge Agility" paradigm.
- To introduce the "Green Elasticity" paradigm.
- To enable the "Carbon/Energy-aware Backpressure" in the 5/6G SBA.
- To integrate the 5/6G SBA with new green AI mechanisms.
- To enable new green 5/6G business models and Decarbonized Service Agreements among stakeholders.
- To demonstrate and validate the project achievements in three use cases.

Funded by the European Union SNS
 6Green project has received funding from the Smart Networks and Services Joint Undertaking (SNS JU) under the European Union's Horizon Europe research and innovation programme under Grant Agreement No. 10109825

<https://www.6green.eu>
 6green-project
 @6GreenProject

The 6Green Objectives

- To promote the transition from classical "Cloud Agility" schemes to a novel "Edge Agility" paradigm.
- To introduce the "Green Elasticity" paradigm.
- To enable the "Carbon/Energy-aware Backpressure" in the 5/6G SBA.
- To integrate the B5G SBA with new green AI mechanisms.
- To enable new green 5/6G business models and Decarbonized Service Agreements among stakeholders.
- To demonstrate and validate the project achievements in three use cases.

Ground Breaking Innovations

#1 Edge Agility
The Edge Agility paradigm is meant to provide smart, fast, and automated horizontal scalability to vertical application and related slices across the 5/6G edge-cloud continuum.

#2 Green Elasticity
The provision of energy-aware, hardware-assisted acceleration to network functions and vertical applications to enable smart vertical scalability across the whole 5/6G ecosystem.

#3 Energy-Aware Backpressure
The design of a set of cross-domain observability mechanisms and analytics, fed by hardware-level energy consumption metrics, to evaluate the energy and the carbon footprint ascribable to a vertical application or a slice.

6Green Use Cases

Critical Operation Maintenance during Energy-Constraint Disaster Scenarios.

Energy-Efficient Augmented Reality Remote Assistance System.

Zero-Carbon Clientless Virtual Enterprise Desktop as-a-Service.

1st Period Deliverables

- D1.1** Project Handbook -M2-Sensitive
- D1.2** First Data Management Plan-M6- Sensitive
- D1.3** Ethics Handbook -M6- Sensitive
- D2.1** Use and Business Cases, Design and Technology Requirements, & Architecture Specification - M6- Public
- D2.2** Work-in-Progress: Specification and Development of 6Green Enabling Technologies -M18-Sensitive
- D3.1** Work-in-Progress: Enabling Green Interoperability in the 5/6G SBA -M12- Sensitive
- D3.2** Intermediated Release of Software Prototypes for the 6Green SBA -M18- Sensitive
- D4.1** Work-in-Progress: Design and Specification of Green Business Models and Runtime Policies for 5/6G Vertical Applications -M18- Sensitive
- D5.1** First Release of the 6Green Pilot-M18- Sensitive
- D6.1** 6Green Public Website -M3-Public
- D6.2** First 6Green Communication/Dissemination, Exploitation and Standardization Plan-M6-Sensitive
- D6.3** Second 6Green Communication /Dissemination, Exploitation and Standardization Plan -M18-Sensitive

Follow us!

 [@6GreenProject](https://twitter.com/6GreenProject)

 [6green-project](https://www.linkedin.com/company/6green-project)

 www.6green.eu



Call Topic ID: HORIZON-JU-SNS-2022-STREAM-A - 01 -04

Project Coordinator: CNIT - Prof. Roberto Bruschi

Start Date: 1st January 2023

Duration: 36 months

